

Lisbon Double Bedstead

Light oak

Length:148cm

Width :199cm

Height:100cm

DEAR CUSTOMER



Thank you for purchasing your new piece of furniture from Dunelm.

We put a lot of effort in the design and construction of our products to ensure they set the standard for quality, durability and ease of assembly.

If for any reason you feel we haven't lived up to the high standards we set ourselves, please don't hesitate in contacting us on 03451 656565 where our team will be very keen to understand what has gone wrong and, more importantly, put it right.

The Next Step...

There is no need to feel daunted by the number of parts and fittings in front of you, we have compiled this straight forward, step-by-step guide to make sure that assembling your furniture is as easy as 1, 2, 3.

Before you begin, we advise that you check that you have everything you need to get started.

TOP TIP

Find a space to spread everything out across the floor before you begin assembling the item. Lay each panel down on a clean and level area, ideally in the room of intended use, ensuring there is enough room to manoeuvre around the item. It is recommended that two people assemble this product together.

The full list of furniture parts, fixtures and fittings, as well as the tools you will need for assembly can be found on page 2, 3, and 4 of this manual.

TOP TIP

Identify all of the fittings, make sure that you have them all prepared and familiarise yourself with each component, to make things easier when you are putting it all together.

Safety and Care Advice

IMPORTANT - The first step you need to take is to ensure your safety!

Please take the time to read and understand these instructions before assembling your furniture.

Please keep these instructions for future reference.

Keep children and animals away from the assembly area.

This furniture contains small parts that could cause choking if swallowed.

Keep all plastic wrapping materials away from babies and children to avoid danger of suffocation.

Ensure that all packaging is disposed of carefully and responsibly.

From time to time check that there are no loose fittings on the unit, re-tighten when necessary.

Two people may be required for the assembly of this product.

Once items are part or fully assembled they are not returnable unless faulty.

This item is not for outdoor use – unless stated otherwise.

Some items will be supplied with a wall fixing strap, which we recommend is used to secure the item to the wall, to prevent a child from accidentally pulling furniture over.

Furniture can be dangerous if incorrectly installed. Assembly should be carried out by a competent person. No liability will be accepted for damage or injury caused by incorrectly installed or assembled furniture.

Parts & fittings for the Lisbon Double Bedstead (30276688)

Panel - exploded view

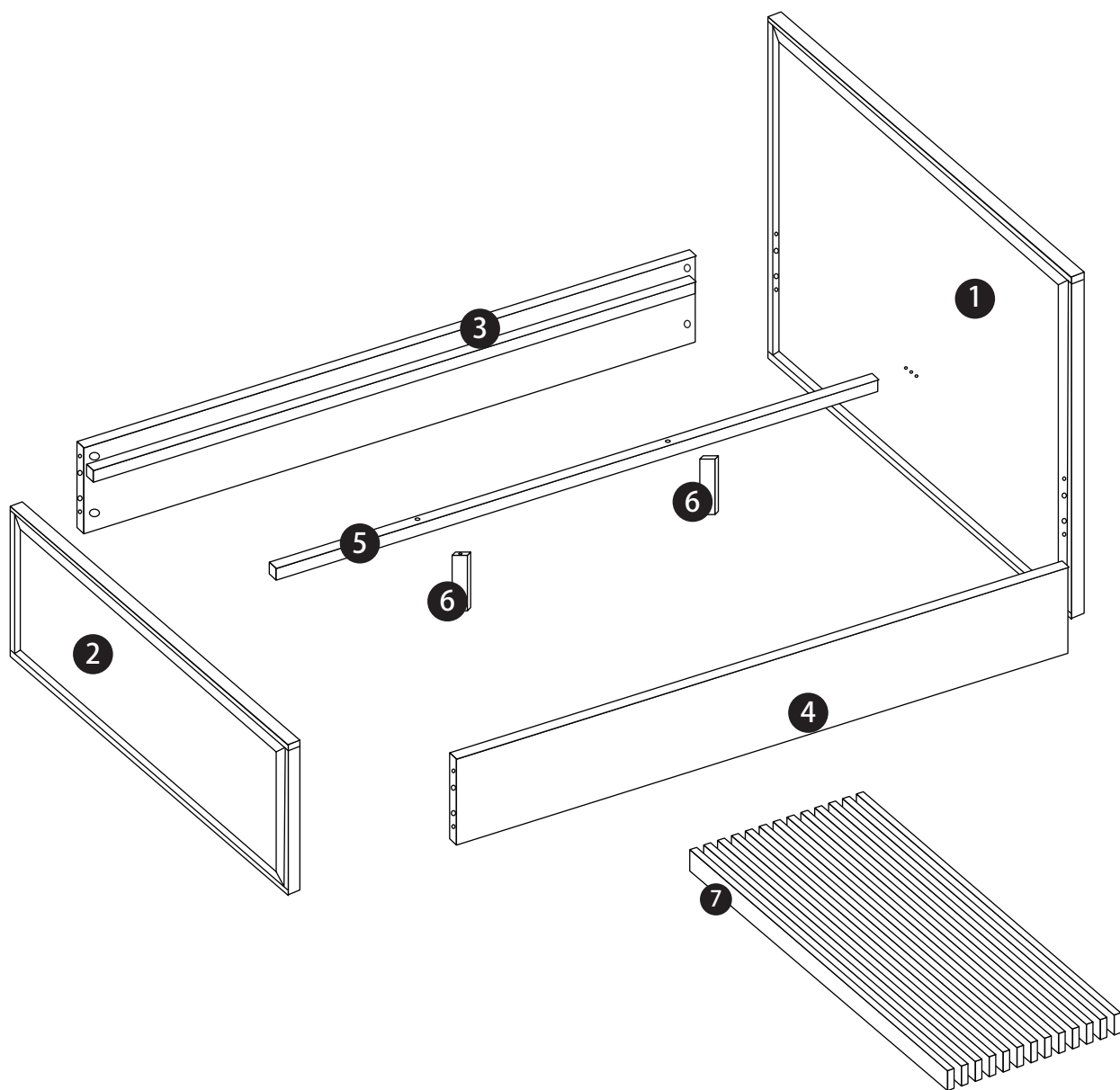

Parts & fittings for the Lisbon Double Bedstead (30276688)

Panels - plan view

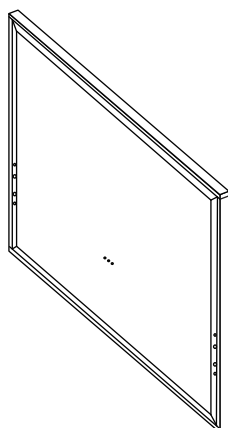

1 Headboard

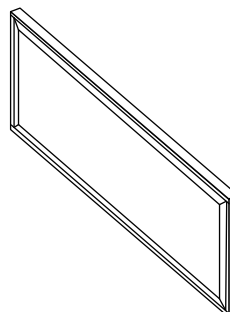

2 Footboard

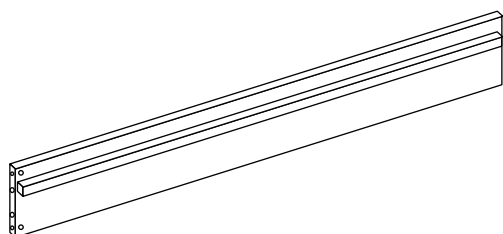

3 Left side rail

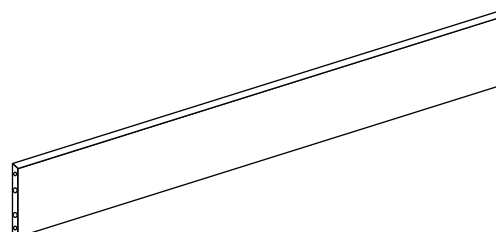

4 Right side rail

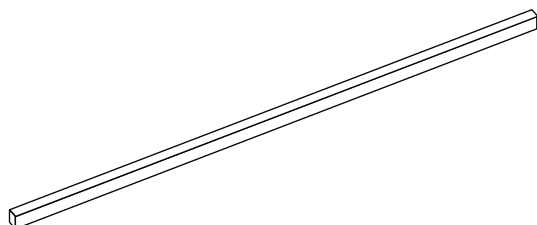

5 Center rail





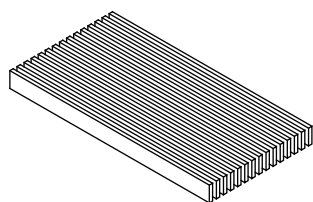









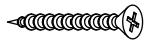

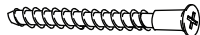

6 Leg x 2

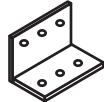
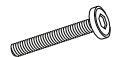

7 Slat

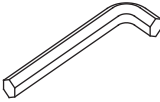
Parts & fittings for the Lisbon Double Bedstead (30276688)

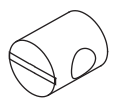
Fittings

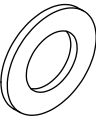
<p>A</p>  <p>50mm Wooden dowel x4</p>	<p>B</p>  <p>30mm Wooden dowel x4</p>	<p>C</p>  <p>Ø4x35mm Screw x15</p>	<p>D</p>  <p>Ø4x12mm Screw x12</p>
<p>E</p>  <p>Ø7x50mm Screw x2</p>	<p>F</p>  <p>Threaded Rod x4</p>	<p>G</p>  <p>Half round nut x 4</p>	<p>H</p>  <p>Hexagonal nut x 4</p>
<p>I</p>  <p>Adjustable foot x2</p>	<p>J</p>  <p>Plastic screw hole cover x4</p>	<p>K</p>  <p>Metal bracket x 2</p>	<p>L</p>  <p>Ø8x50mm Screw x4</p>
<p>M</p>  <p>Mat x4</p>	<p>N</p>  <p>Allen key x1</p>	<p>O</p>  <p>Wrench x1</p>	<p>P</p>  <p>Metal nut x 4</p>
<p>Q</p>  <p>Washer x4</p>	<p>R</p>  <p>8mm Washer x4</p>		

Tools Required

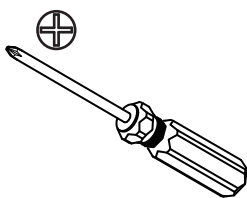

Phillips screwdriver
(medium)

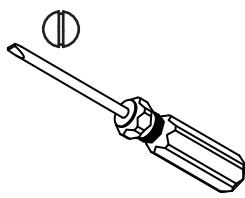

Flatblade screwdriver
(medium)

Before you start

Check the pack and make sure you have all the parts listed above.
If not, contact the helpline on 03451 656565 who will be able to help you.

When you are ready and sure that you have the right tools to hand, you will need plenty of space and a clean dry area for assembly.

Ready?

Follow this step-by-step guide

1

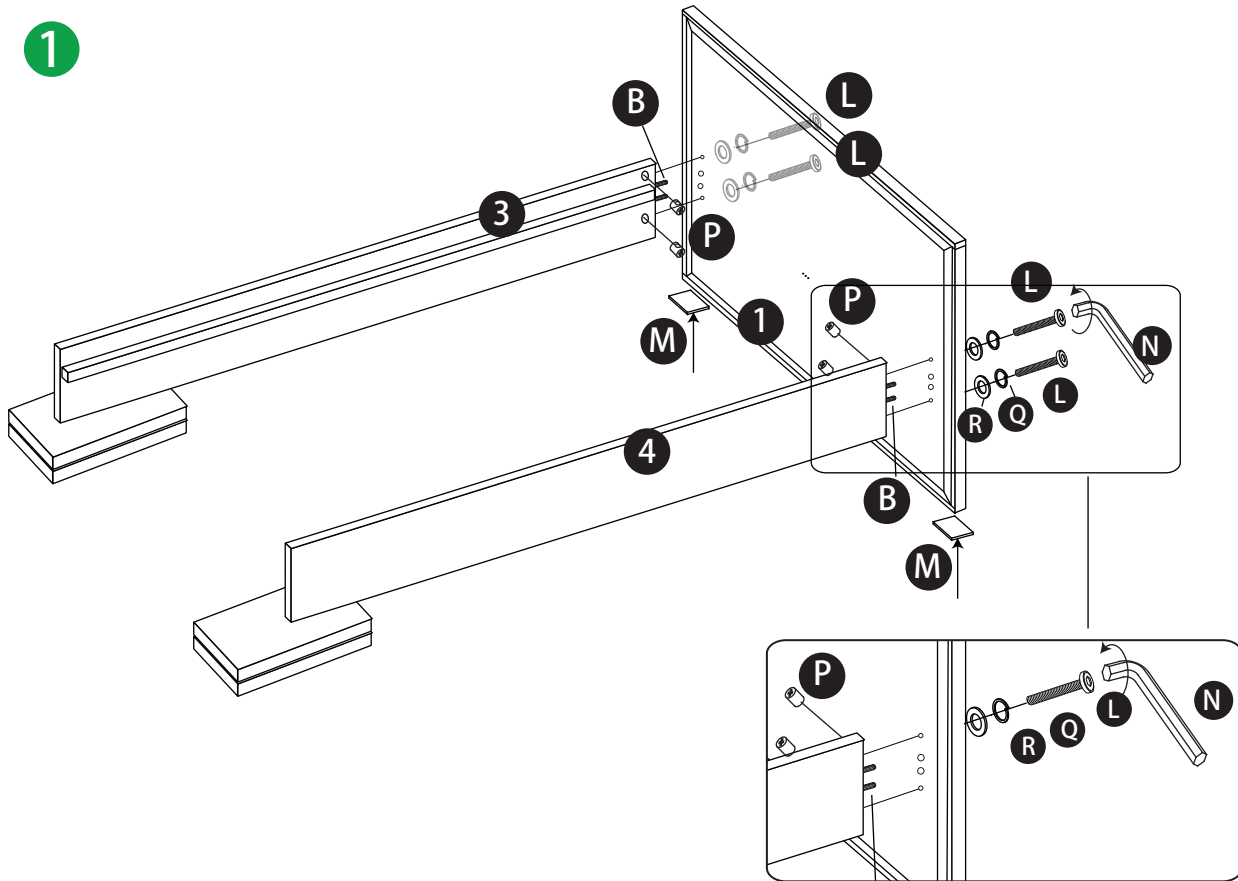

2

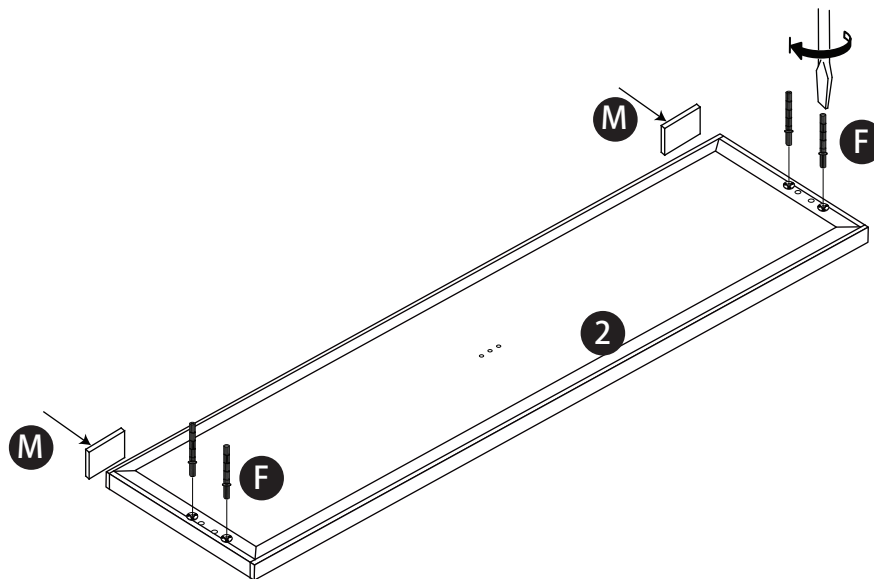

3

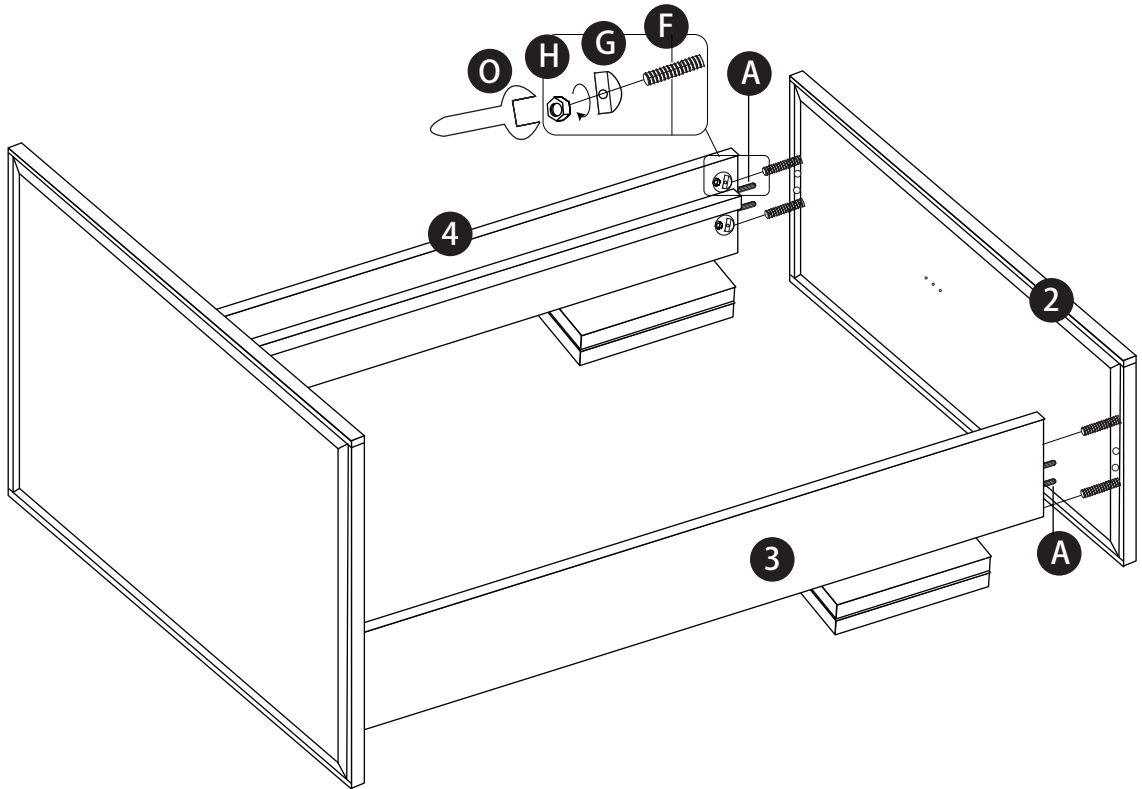

4

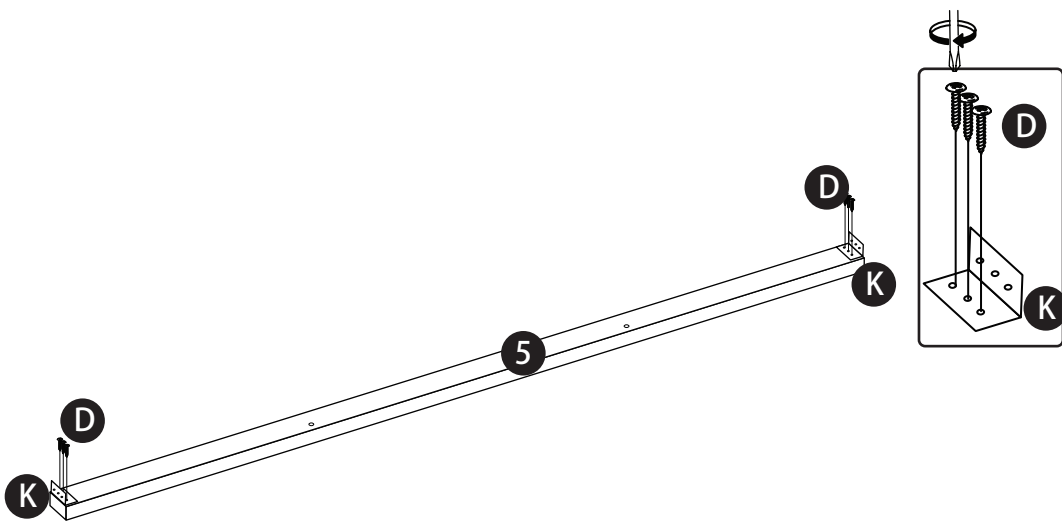

5

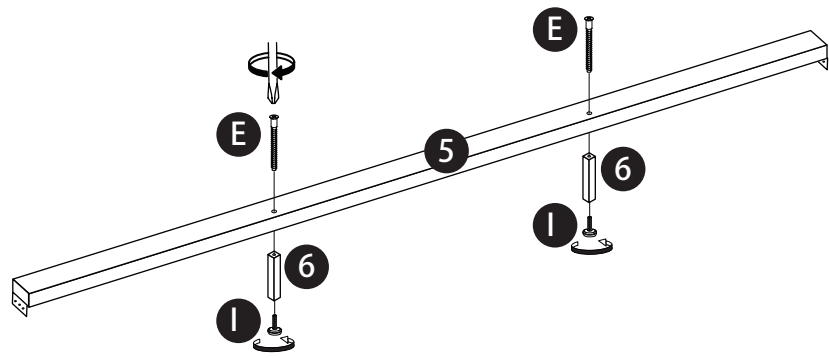

6

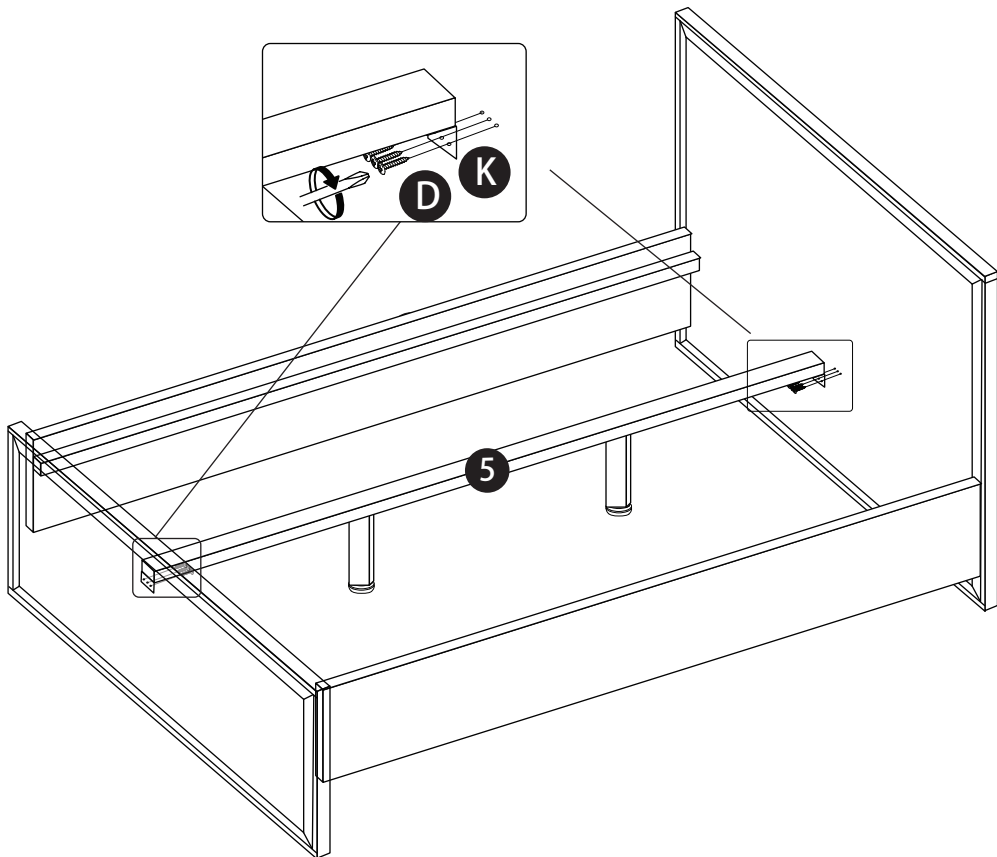

7

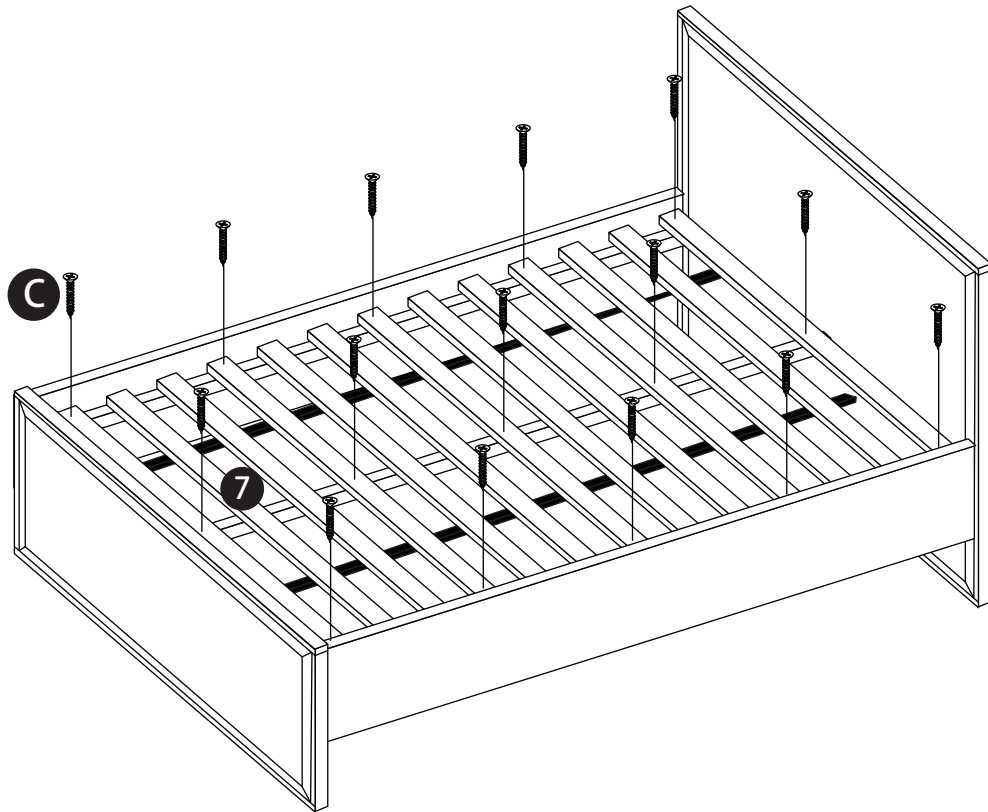

8

Use stickers (J) on all visible holes.

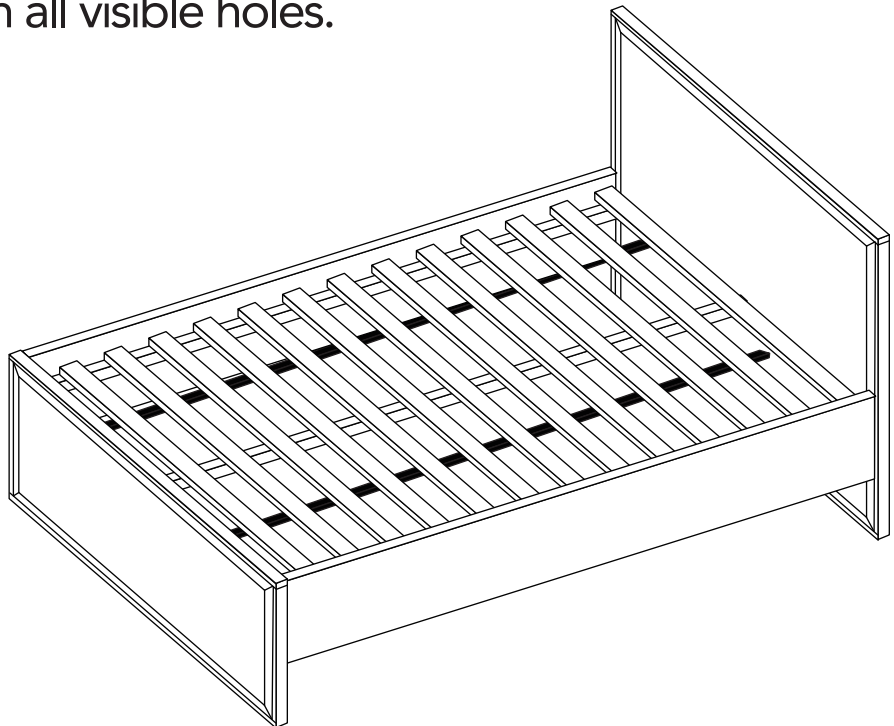
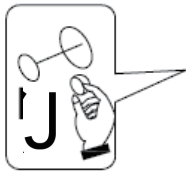

Care and maintenance

Wood

Only clean using a damp cloth and mild detergent, do not use bleach or abrasive cleaners.

From time to time check that there are no loose screws on this unit.

Wood is a natural product and each piece is individual. The colour will mellow over time and new items can vary in shade from items that you have already purchased. We also recommend that any ornaments, coasters and items placed on the product are periodically moved around to allow the colour to mellow evenly.

As a natural product, wood is affected by temperature and humidity. We recommend that you avoid placing the furniture directly in front of heat sources such as radiators or fires as this can cause cracking or warping over time. Always use mats and coasters to protect the surface when placing items on the furniture. This will help to protect the finish from heat, liquids or items that might scratch your furniture.

Remove any spills immediately to avoid staining. Dust regularly with a soft lint free cloth or duster.

The use of abrasive polish or silicon based polishes is not advised as these can affect the polished finish and joints over time. Always lift your furniture into place, avoid dragging it across the floor as this can cause damage to joints.

For accidental spills or stains

Never rub or scrub with a cloth as this could damage the fabric and remove the colour.

Blot or soak up spills immediately using a dry soft colourfast cloth.

Do not use washing up liquid, detergents or bleach to remove stains.

If using specialist upholstery cleaner, always follow the manufacturer's instructions and always test on a hidden area to check colour fastness. Allow the test patch to completely dry first. If the fabric colour is affected, do not use this cleaner on the rest of your product and consult a specialist.

Finally, we hope you enjoy your furniture for many years to come and thanks again for your purchase.

