





ASSEMBLY INSTRUCTION (Double / King Bedstead)

No	Name of Hardware	Fig	Q.ty
1	Bolt M6 x 10		8
2	Bolt M6 x 35		4
3	Allen Key(K5)		1
4	Allen Key(K4)		1



A - HEAD BED 1X

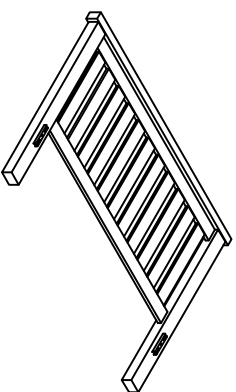
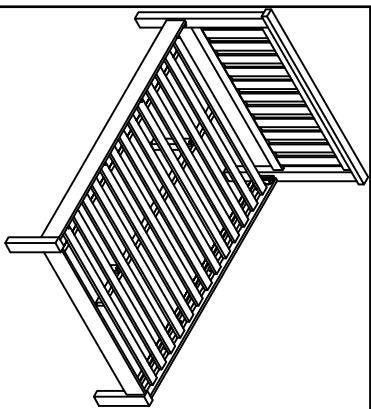
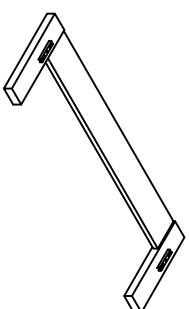

B - FOOT BED 1X

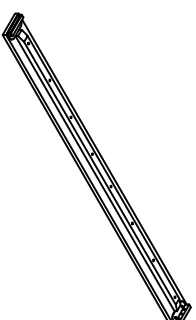

C - SIDE BED 2X

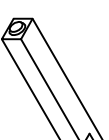

D - LEG 2X

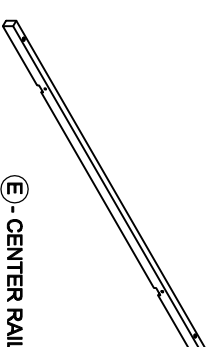

E - CENTER RAIL 1X

STEP1

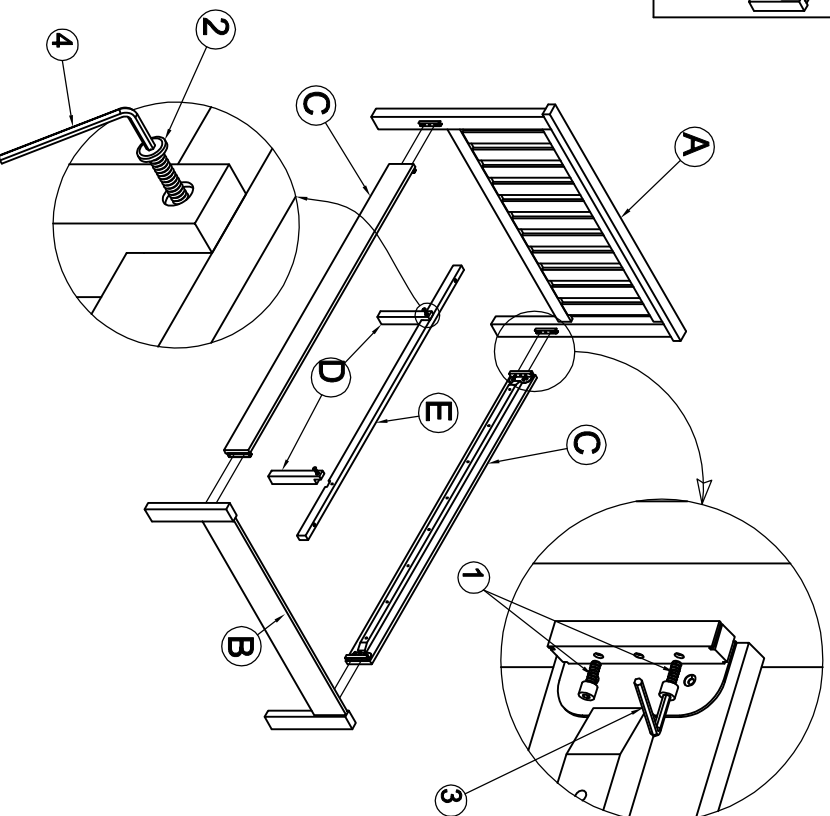

STEP2

NOTE: SLAT BEDS ARE ON A DIFFERENT PACKAGE
HARDWARE 1 ARE INCLUDE IN SLAT BED

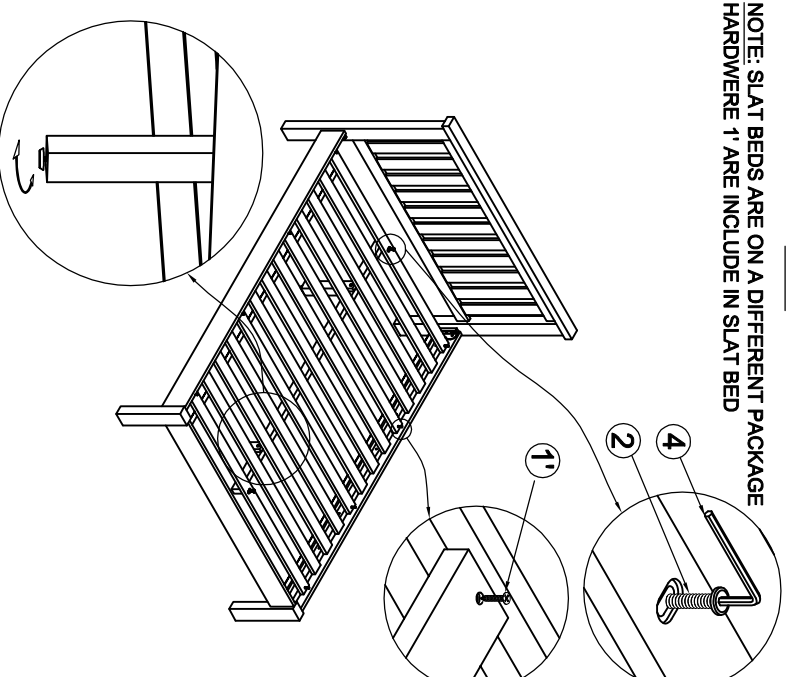

Note: please use adjustable foot for uneven floors.