

Bay Curtain Pole

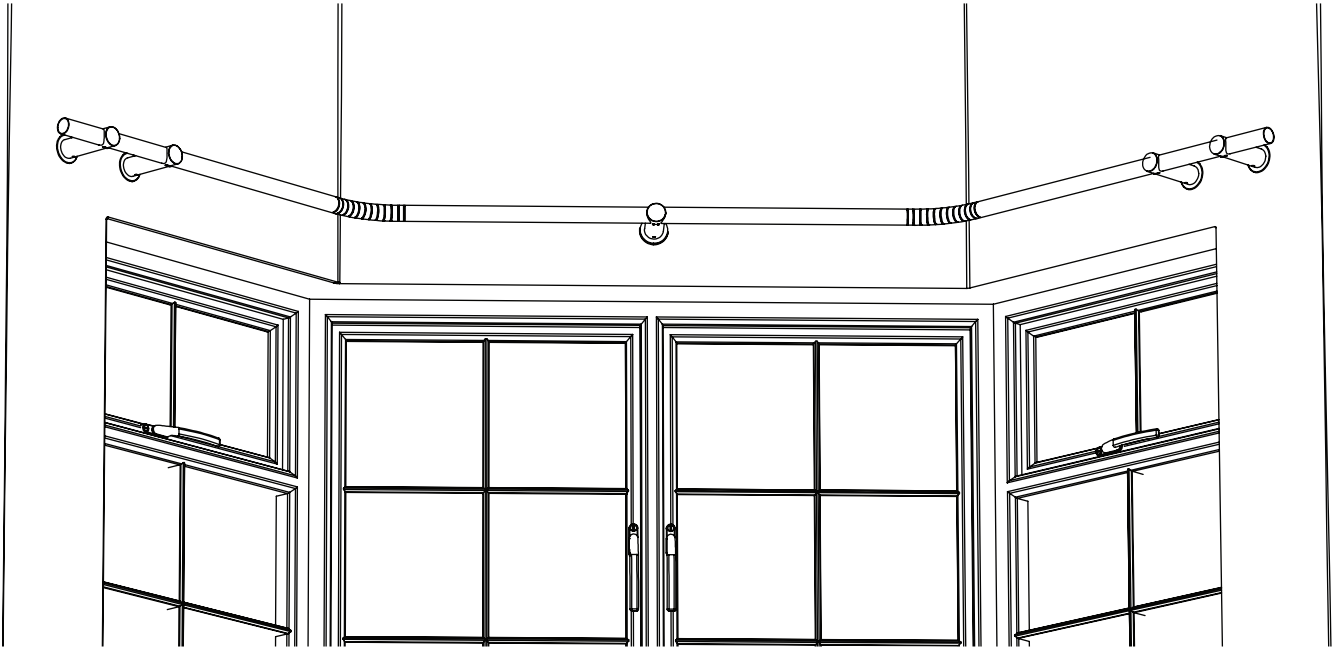

It is recommended that this product is installed by persons competent in DIY, if in doubt consult a professional.

Two people are required to install this product.

Read instructions fully, before installation.

Depending on the type of wall you are installing this product, additional fittings maybe required. If you are unsure, consult you local hardware store for advise.

Tools Required

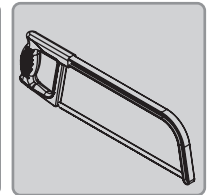
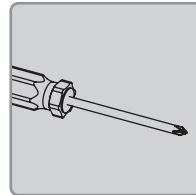
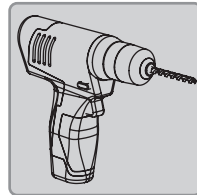
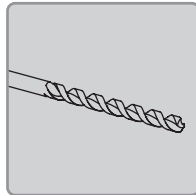
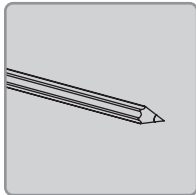
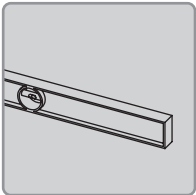
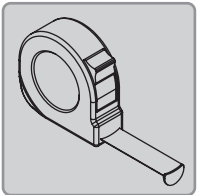

Parts included with Bay Curtain Pole

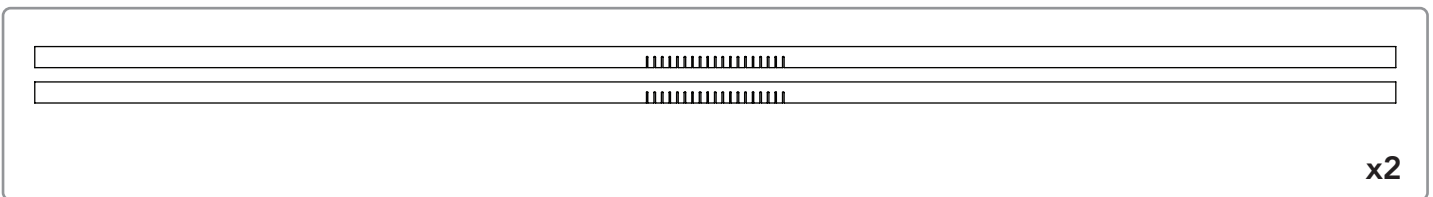
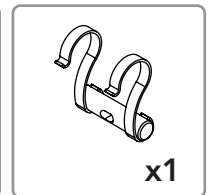
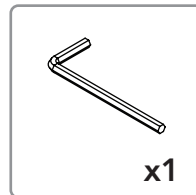
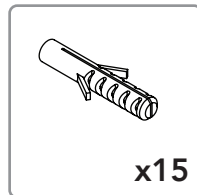
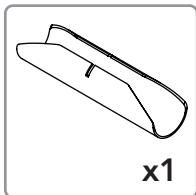
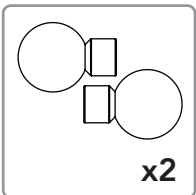
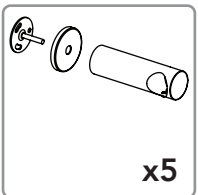

**PLEASE CHECK PAGE 3
BEFORE PREAPREING TO
BEND THE POLE**



Prepare Wall

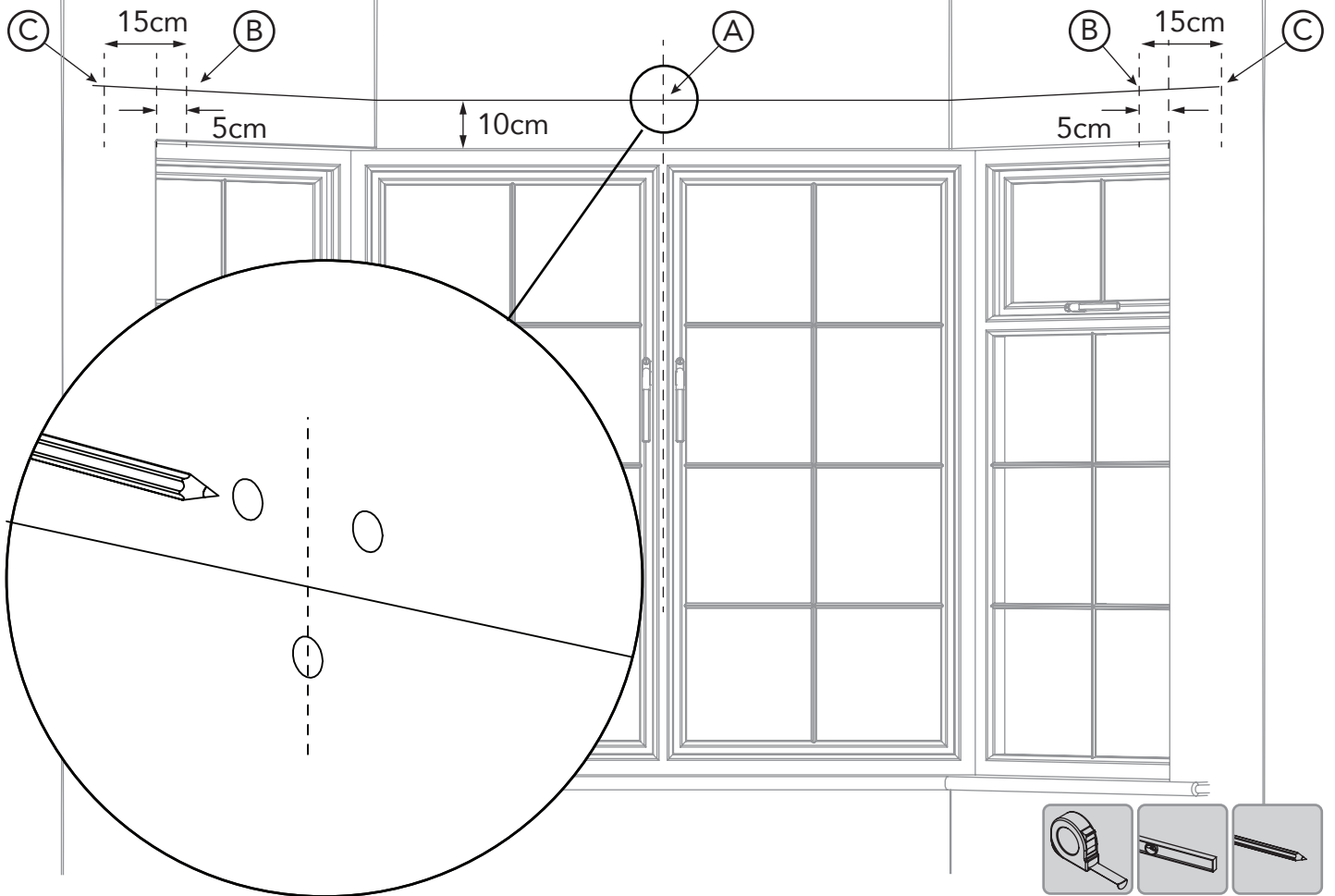

Using a tape measure and level, whilst using the wall bracket as a guide, mark the position of the brackets on the wall as shown.

Fit Wall Brackets

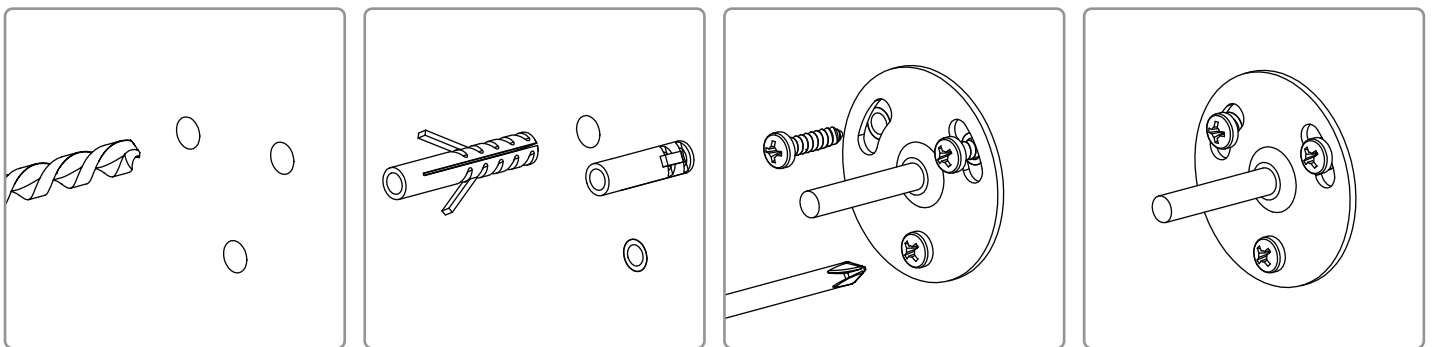

Drill holes in marked positions & fit wall plugs
Screw wall plate to wall

x5



Bend Poles

Bend the poles with the slots facing toward the inside of the bend
Use two people to help bend the pole

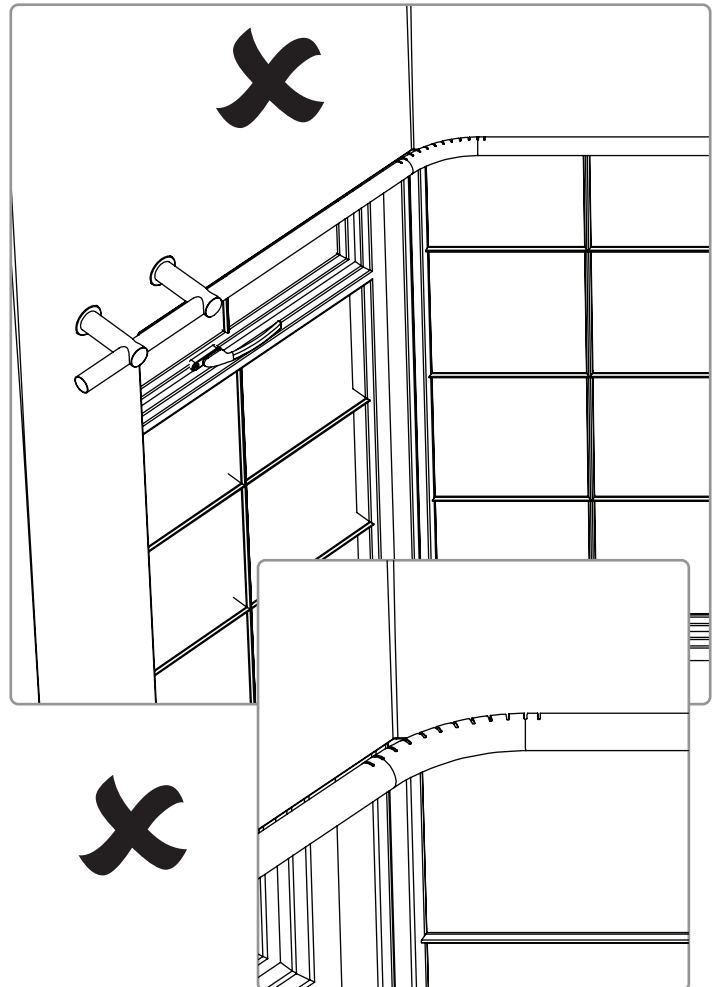
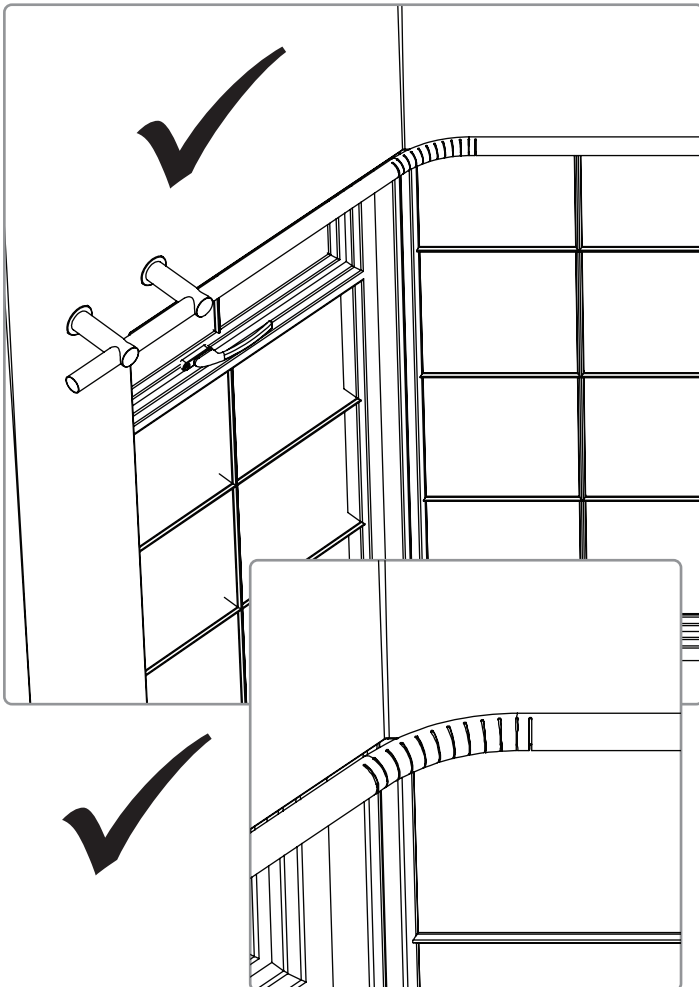
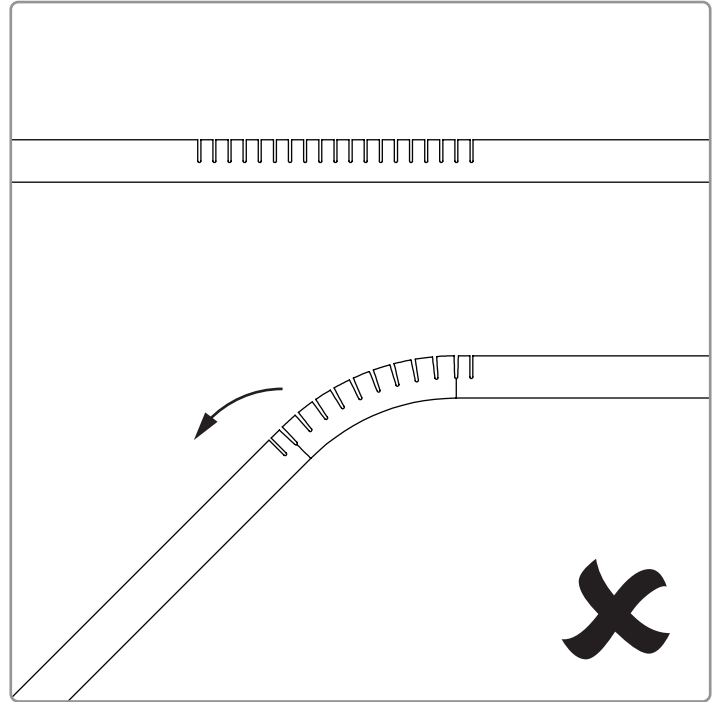
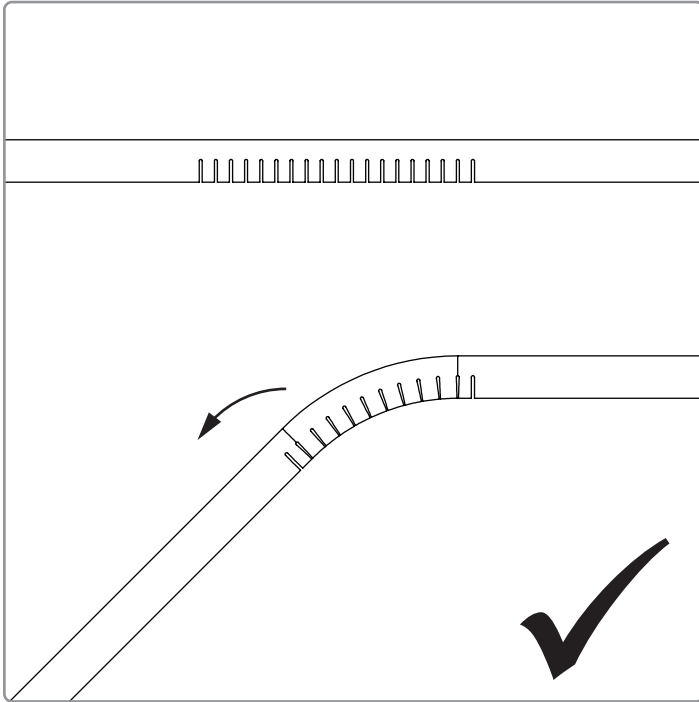

Bend Poles

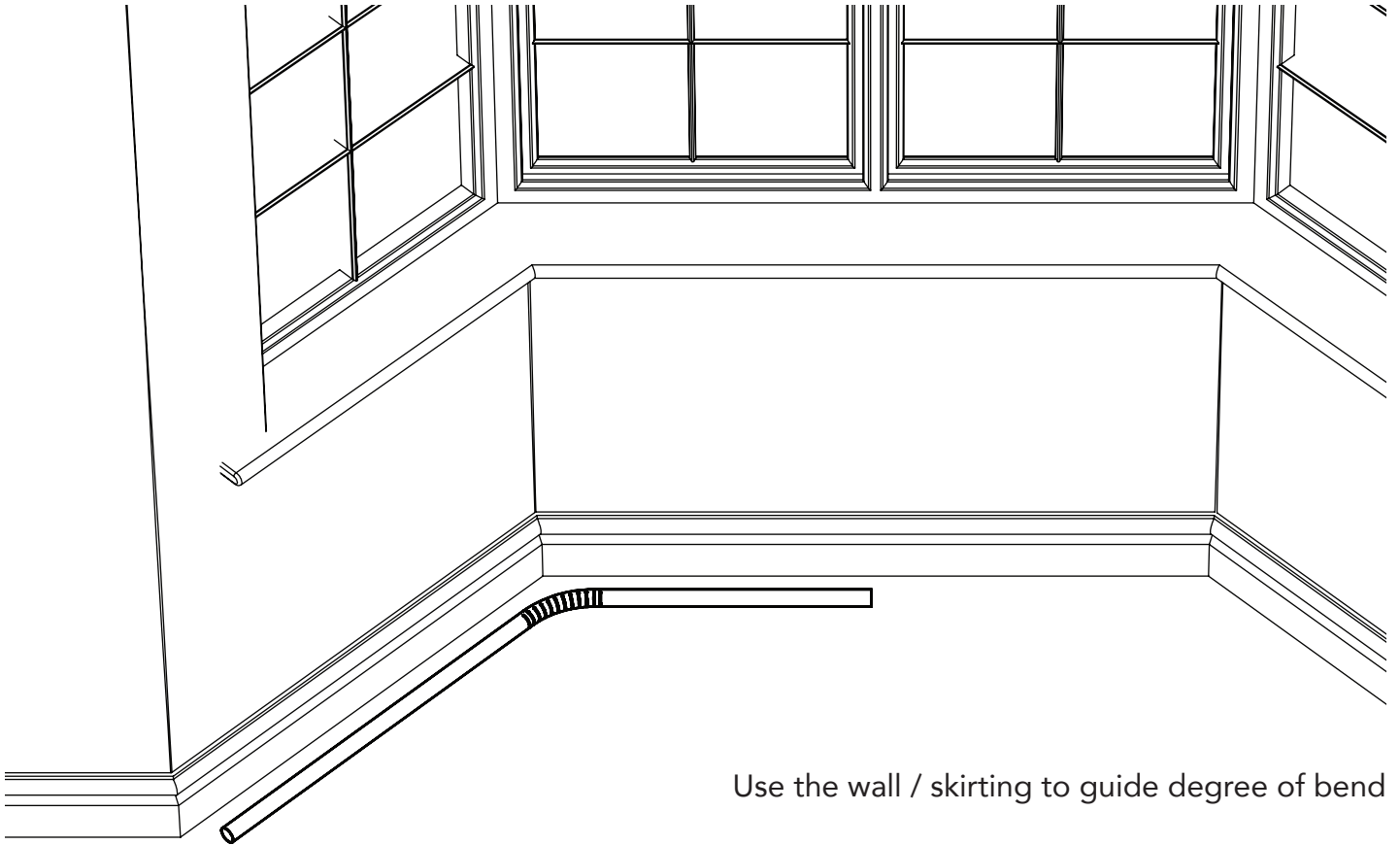

Cut Down Poles

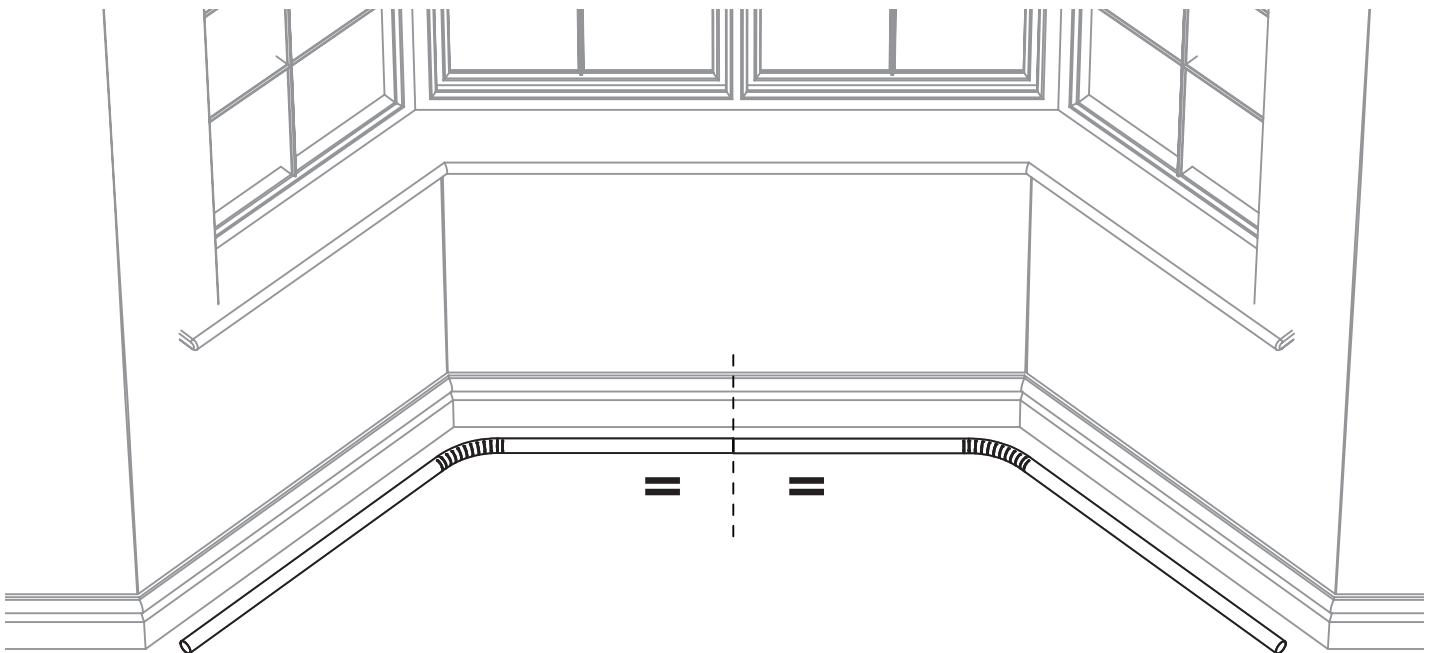

Cut poles to fit window

Equal lengths should be cut from each pole to hide join between middle bracket

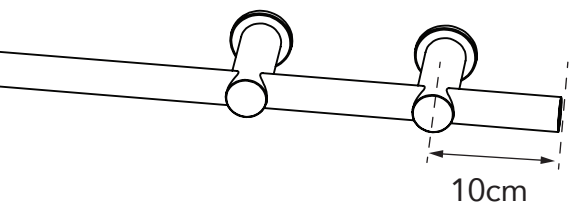

The outward end of the pole should finish approximately 10cm away from the last bracket

Assembly - Step 1

Fit the centre bracket to the wall in the order shown
Tighten the screw at the bottom rear of the bracket

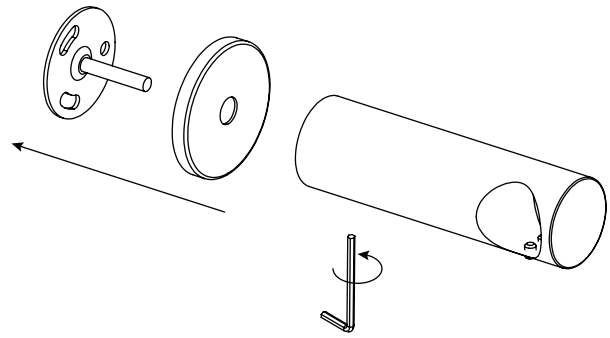

Assembly - Step 2

Feed curtain & two brackets onto one section of pole ensuring the brackets do not slide on from middle joint.

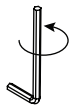

DO NOT TIGHTEN SCREWS

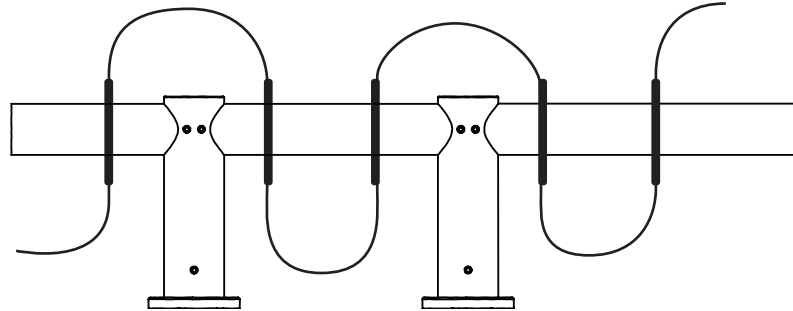

Assembly - Step 3

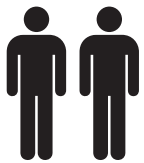
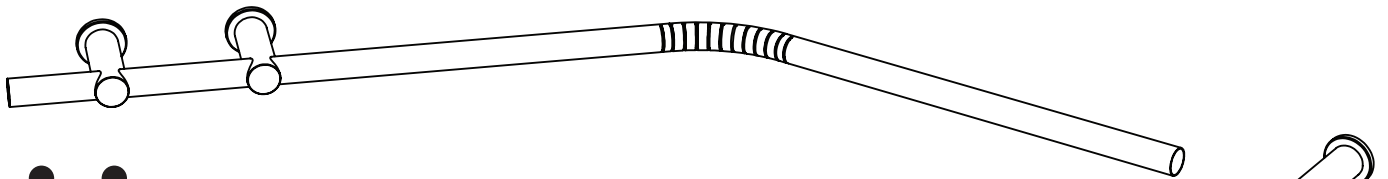

Slide the middle end of the pole into the centre bracket
Fit end brackets in the same order as Step 1
CAUTION - ONLY TIGHTEN THE REAR SCREW!

Assembly - Step 4



Fit Joiner into middle section of pole
Repeat Step 2 & Step 3 for the other pole

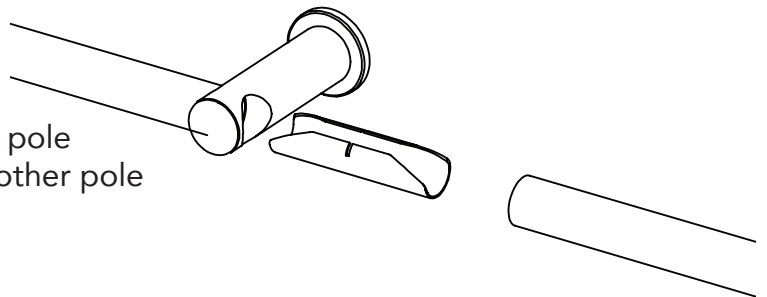

Assembly - Step 5

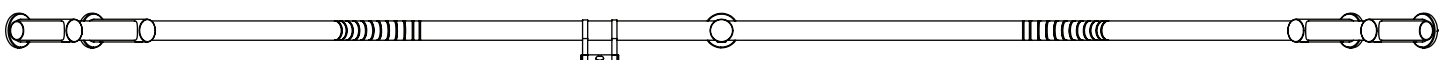

Clip the included level to the pole and tighten all screws ensuring the pole remains level

Assembly - Step 5

Check the function of the pole and correct position if needed.
When everything is correct, slide finials onto the end of the pole and tighten screw.

